

Roberto Sport srl

Via A. Casale 63/A (Zona Industriale), 10010 Lessolo, TO
ITALY

P.I. 05961970018

Tel. +39 0125 58848 - Fax +39 0125 58851

info@robertosport.it / www.robertosport.it / 



EXPORT

Thank you for choosing one of Roberto Sport's products. Our tables are famous for their quality and accuracy of their components. Roberto Sport has been producing table soccer, pool and hockey tables for more than 65 years. Huge experience and tradition, constant research and innovation have brought Roberto Sport's name as a synonym of the "**Made In Italy**" football tables all over the world.

GENERAL WARNINGS



Unpacking and assembly operation should be carried out entirely by adults. Keep children away throughout all steps. All small parts such as bolts, screws etc., not yet assembled, and nylon bags might be swallowed or inhaled.

CARE & MAINTENANCE



The model you just bought is for INDOOR USE. For this reason we suggest you to install it in sheltered environment, with low humidity degree and direct sun beam free.

In order to keep your tables performance at a high level, we suggest you clean it periodically by using a humid dust cloth. For difficult stain you may use abrasive-free detergents. For an utmost sliding rods: we suggest you get the external part of the rod lubricated (the one in touch with the bushing) along with the rod's internal part by using a silicon spray. **Roberto Sport** uses and supplies a special silicon spray studied, produced and tested for these purposes. Do not use grease; it holds the dust and might block the rod sliding. The telescopic rods assembled on this table are of a highly safe. To prevent rods bending, we recommend you do not load weight on the rods when extended.



For any problem you might have, or any info you might need, do not hesitate to visit our web site: www.robertosport.it or contact us at: sales@robertosport.it

WARRANTY

Roberto Sport has a two- year warranty for its products starting from the acquisition date. Warranty covers manufacture defects only; it doesn't cover damages caused by misuse or assigned to be due to wear & tear. A manufacture defect must be reported at the earliest by a written communication within two months. A written notification must be sent to the vendor. Roberto Sport is committed to restore the table with no charge on the buyer by repairing or replacing the damaged part/parts or by offering a discount.



PART LIST

1		Lubrificant spray
10		White ball
1		Scoring unit

Material for legs

4		Aluminium leg
16		Screw 8x40
16		Metal flat 8x32
16		Metal flat with nut
8		Plastic bracket

Material for rods

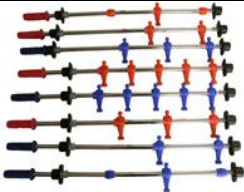
35		Screw 5x20
1		Set complete of rods

Material for aluminium border top

7		Vite 4,5x16
---	---	-------------

ASSEMBLY INSTRUCTIONS

The football table is packed in a carton box with the rods and legs to be assembled. The assembly operation is very simple and needs about one hour. To start please follow the below instructions.

Please read and keep these instructions for future reference.

You have received your table with the top cover, at least you must remove it.

Legs assembly

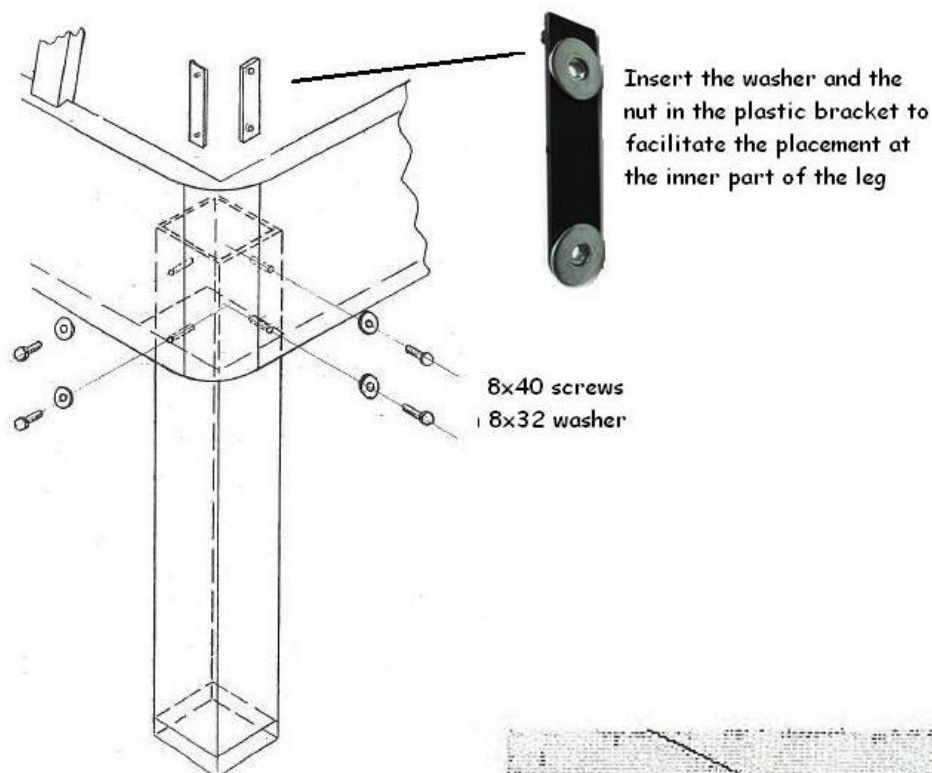

Fixing the coin mechanism

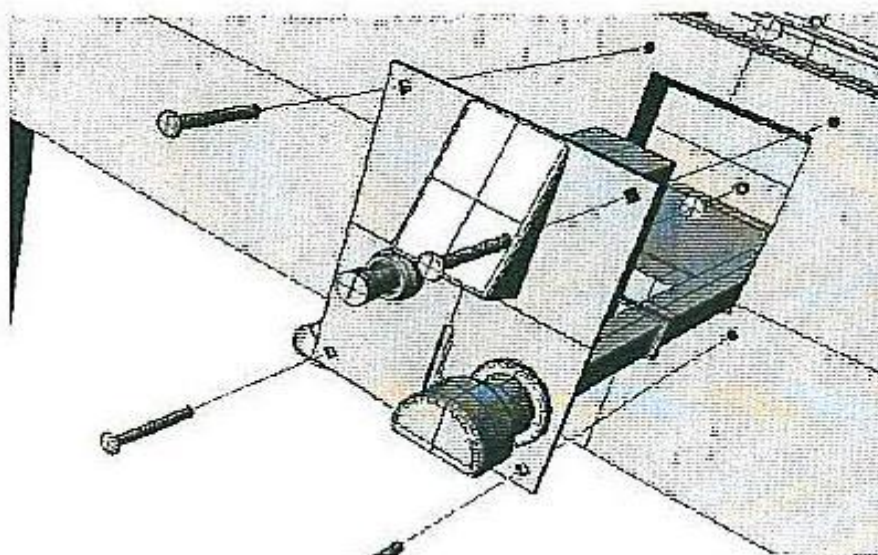

1. Insert the coin mechanism in the slot and hook the tie rod to the ball release mechanism

2. Fix the coin mechanism with its screws, washers and bolts

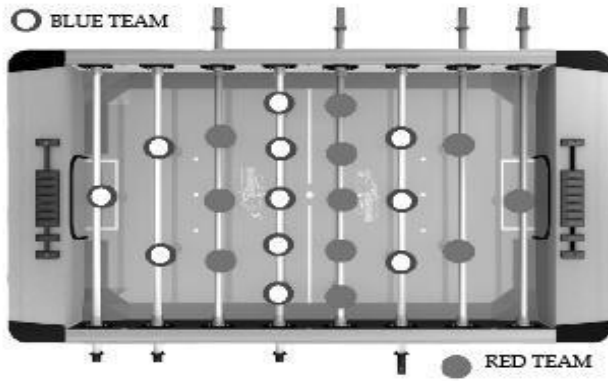

1. insert the rods in the holes starting from the handles side

2. set the bushing with the screw holes upwards

3. fix the bushing with the 5x20mm screws

Fix the scoring unit using its screws



Fix the aluminium edge with the 4.5x16 screws (3 on each side)

metal flat + nut d.5mm

Plastic spacer

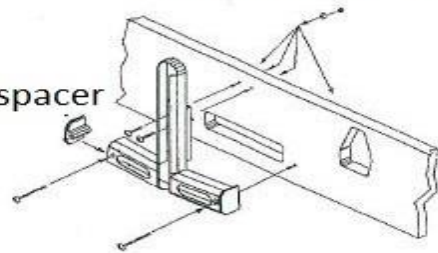

Top cover and metal part for ball exit assembly

